

INTEX® OWNER'S MANUAL

SOLAR HEATER MAT

READ AND FOLLOW ALL INSTRUCTIONS BEFORE USING THIS PRODUCT

⚠ WARNING

- To reduce the risk of injury, do not permit children to use this product. Always supervise children and those with disabilities.
- Assembly and disassembly by adults only. This product is not a toy.
- Never allow anyone to step, stand, sit or jump on this product.
- Turn the pump off before installing, servicing, cleaning or adjusting this product.
- Do not block the outlet of this product while the pump is running.

FAILURE TO FOLLOW THESE WARNINGS MAY RESULT IN SERIOUS INJURY OR DEATH.

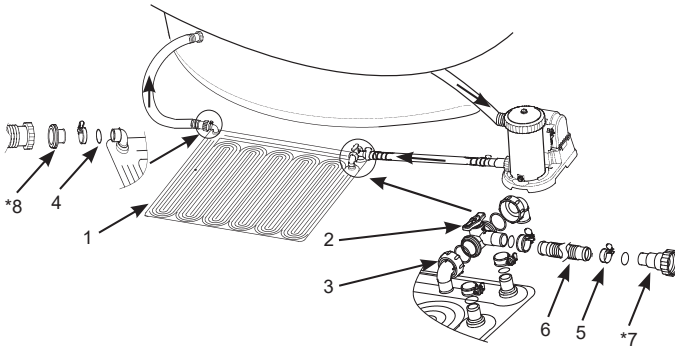

NOTE: Drawings for illustration purpose only. May not reflect actual product. Not to scale.

REF. NO.	DESCRIPTION	QTY.	SPARE PART NO.
1	Solar heater mat	1	11956
2	Bypass valve	1	11954
3	Elbow joint	2	11953
4	Hose seal	5	10134
5	Hose clamp	5	11489
6	Hose	1	11955
*7	Adaptor A (For 1-1/4" hose only)	1	10849
*8	Adaptor B (For 1-1/2" hose only)	1	10722

©2023 Intex Marketing Ltd. - Intex Development Co. Ltd. - Intex Recreation Corp. All rights reserved/Tous droits réservés/Todos los derechos reservados/Alle Rechte vorbehalten. Printed in China/Imprimé en Chine/Impreso en China/Gedruckt in China.

®™ Trademarks used in some countries of the world under license from®™ Marques utilisées dans certains pays sous licence de/Marcas registradas utilizadas en algunos países del mundo bajo licencia de/Warenzeichen verwendet in einigen Ländern der Welt in Lizenz von/Intex Marketing Ltd. to/à/a/ an Intex Development Co. Ltd., Hong Kong & Intex Recreation Corp., P.O. Box 1440, Long Beach, CA 90801 • Distributed in the European Union by/ Distribué dans l'Union Européenne par/Distribuido en la Unión Europea por/Vertrieb in der Europäischen Union durch/Intex Trading B.V., Ettenseweg 46, 4706 PB Roosendaal - The Netherlands • Distributed in the UK by Unitex Service (UK) Limited, 21 Holborn Viaduct, London EC1A 2DY, UK. www.intexcorp.com

INTEX®

SAVE THESE INSTRUCTIONS

General

- This product is for use with storable pools only. Do not use with permanently-installed pools.
- Solar heater mat size (flat, before fill): 47" X 47" (1.2 m X 1.2 m). Surface area: 11 ft² (1m²).
- Suitable for above ground pools up to 8,000 gal (30,280 L).
- Compatible with pump flow rate less than 1,500 gal/hr (5,678 L/hr).
- Increases the pool water temperature by approximately 5-9°F (3-5°C) depending on weather and ambient conditions.

Site Preparation and Requirement

- Select an area that receives maximum direct sunlight for better performance. Face the solar heater mat in the direction of the sun's natural path.
- The selected area shall be free of sharp objects, stones and debris that can puncture the product, and away from traffic. Keep all pets away from this product.
- Clear all grass and other vegetation from the selected area as grass and vegetation under the product will die and may cause odor and slime to develop. Certain types of grass such as St. Augustine and Bermuda, may grow through the product. Grass growing through the product it is not a manufacture defect.
- Extend the life of the product, place a tarp or mat on the ground beneath the solar heater mat.
- Do not place the product on the roof or any structure, or above the water level of the pool.

Setup instructions

These instructions assume that the pool and filtration system are already assembled, and there is a pool water return (pool water inlet) hose attached.

1. Unroll and place the solar mat on the selected area where it will receive the maximum sun exposure. See Fig 1.
2. Position the solar mat between the pool water return hose and the filter pump outlet, after the water is filtered. If you are using a saltwater system or a chlorinator, it must be connected in-line following the solar heater mat.
3. Place the bypass valve over the 2 openings on the solar mat. Ensure the sign "A" marked on the elbow joint (3) matches the sign "A" on the solar mat opening. Secure the bypass valve (2) assembly to the solar mat with hose clamps (5). Ensure all the elbow joints and hose clamps are securely tightened. See Fig 2.
4. Attach one end of the short hose (6) to the remaining opening on the bypass valve (2) and secure the hose with a hose clamp (5). See Fig 3.
5. Before disconnecting any hoses, turn off the filtration system and close or cover all pool inlet and outlets to prevent water from flowing out.

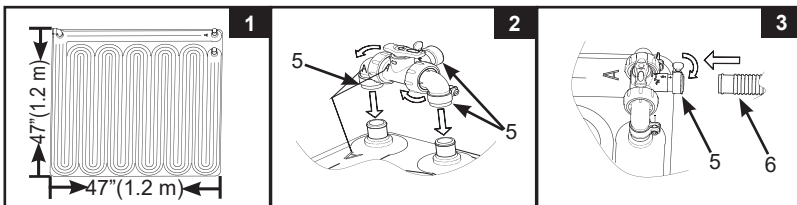

SAVE THESE INSTRUCTIONS

Connection to 1-1/4"(32 mm) hose with clamp

1. Disconnect the pool water return hose from the pump outlet.
2. Connect the other end of the short hose (6) to the pump outlet. Secure the hose with hose clamps (5). See Fig 4.
3. Connect the other end of the pool water return hose to the solar heater mat outlet. Secure the hose with hose clamp (5). See Fig 5. Make sure all the hose clamps are securely tightened.

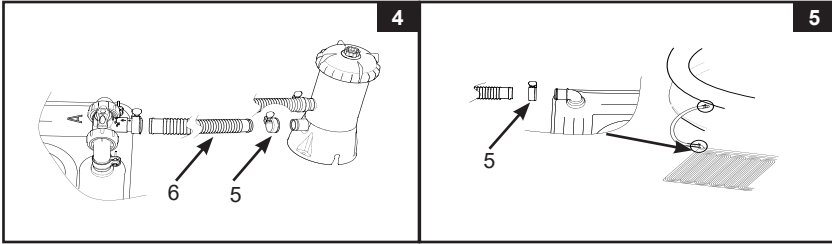

Connection to 1-1/2"(38 mm) hose with adaptor

1. Disconnect the pool water return hose from the pump outlet.
2. Connect the adaptor A (7) to the pump outlet and attach the other end of the short hose (6) to the adaptor A. Secure the hose with hose clamp (5). See Fig 6.
3. Attach the adaptor B (8) to the solar heater mat outlet; then connect the other end of the pool water return hose to the adaptor B (8). Ensure the hose clamp (5) and hose nuts are securely tightened. See Fig 7.

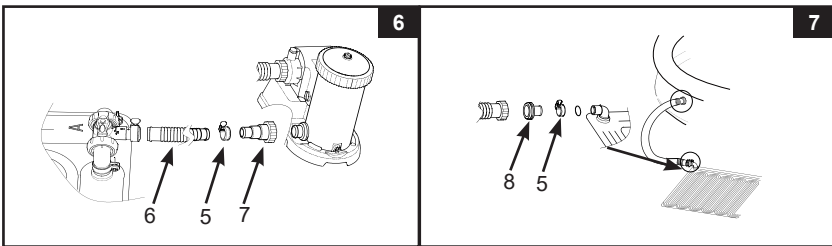

SAVE THESE INSTRUCTIONS

Operation

269
IO

1. Open or uncover all pool inlet and outlets, and then turn on the filtration system. Make sure all trapped air is released from the circulation system. Refer to the filter pump owner's manual for details.
2. Turn the bypass valve (2) handle clockwise to the "☞" position to allow the filtered water to flow through the solar heater mat. See Fig 8.
3. Turn the bypass valve handle counterclockwise to the "🔒" position to bypass the solar heater mat and allow the filtered water to flow straight to the pool. See Fig 9.

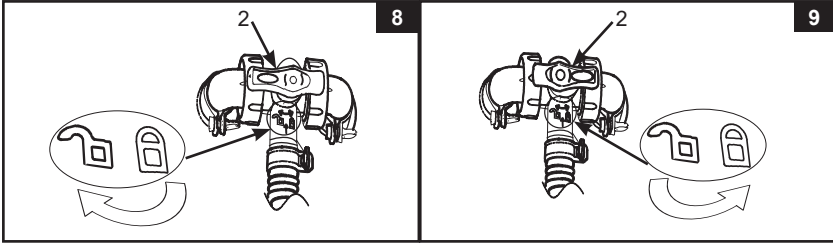

4. Place a solar cover and/or a pool cover whenever the pool is not in use or occupied to prevent heat loss.
5. To increase the heating performance, you may connect two or more solar heater mats together in series with the short hose (6). See Fig 10. Check the solar heater mat table for the number of solar heater mats needed.

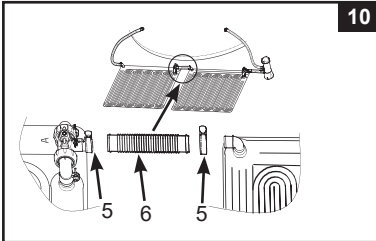

	Pump Flow Rate		Solar Mat (pieces)
	Gals/h	L/h	
Filter pump	330	1,250	1-2
	530	2,006	2-4
	1,000	3,785	3-5
	1,500	5,678	4-6





Maintenance, Winterizing and Storage Instructions

1. Turn off the pump and stop the water from flowing into the solar heater mat. Reverse the setup instructions to disassemble the product from the pool and pump.
2. For cleaning use only mild soapy solution and water. Do not use any chemicals or abrasive brush.
3. Drain all the water from the solar heater mat. Do not allow any standing water inside the solar heater mat to freeze.
4. Be sure that the solar heater mat and all parts are completely dry before storage. Air dry the mat in the sun until completely dry before folding. Sprinkle some talcum powder to prevent the solar heater mat from sticking together and to absorb any residual moisture.
5. Lay the solar heater mat flat and roll up loosely.
6. The original packaging can be used for storage. Store in a dry, cool storage location protected from frost.
7. In case of repairs, use only common PVC repair glue and patches.

SAVE THESE INSTRUCTIONS

SOLAR HEATER MAT QUANTITY FOR INTEX POOLS**269
IO**

Number of solar heater mat recommended for larger pools. Based on 8 hours of sunshine exposure per day; heating performance varies depending on weather and ambient conditions, and whether the pool is covered or not at night.

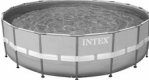
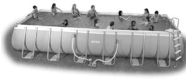
POOL	POOL SIZE	QUANTITY
	6' x 20" (183cm x 51cm)	1
	8' x 30" (244cm x 76cm)	1
	10' x 30" (305cm x 76cm)	1
	12' x 30" (366cm x 76cm)	2
	12' x 33" (366cm x 84cm)	2
	12' x 36" (366cm x 91cm)	2
	15' x 33" (457cm x 84cm)	3
	15' x 36" (457cm x 91cm)	3
	15' x 42" (457cm x 107cm)	4
	15' x 48" (457cm x 122cm)	4
	16' x 42" (488cm x 107cm)	4
	16' x 48" (488cm x 122cm)	5
	18' x 48" (549cm x 122cm)	5
	86-5/8" x 59" x 23-5/8" (220cm x 150cm x 60cm)	1
	102-1/2" x 63" x 25-5/8" (260cm x 160cm x 65cm)	1
	118" x 78-3/4" x 29-1/2" (300cm x 200cm x 75cm)	1
	177-1/4" x 86-5/8" x 33" (450cm x 220cm x 84cm)	2
	10' x 30" (305cm x 76cm)	2
	12' x 30" (366cm x 76cm)	2
	12' x 33" (366cm x 84cm)	2
	12' x 36" (366cm x 91cm)	2
	12' x 39" (366cm x 99cm)	3
	14' x 42" (427cm x 107cm)	4
	15' x 36" (457cm x 91cm)	4
	15' x 42" (457cm x 107cm)	4
	15' x 48" (457cm x 122cm)	5
	16' x 42" (488cm x 107cm)	5
18' x 48" (549cm x 122cm)	6	
	16.5' x 9' x 48" (503cm x 274cm x 122cm)	3
	20' x 10' x 48" (610cm x 305cm x 122cm)	4
	14' x 42" (427cm x 107cm)	4
	14' x 48" (427cm x 122cm)	4
	16' x 48" (488cm x 122cm)	5
	18' x 48" (549cm x 122cm)	6
	9'10" x 5'9" x 31-1/2" (300cm x 175cm x 80cm)	1
	157-1/2" x 78-3/4" x 39-3/8" (400cm x 200cm x 100cm)	2
	9' x 15' x 48" (274cm x 457cm x 122cm)	4
	9' x 18' x 52" (274cm x 549cm x 132cm)	5
	16' x 8' x 42" (488cm x 244cm x 107cm)	3

SAVE THESE INSTRUCTIONS