

INTEX® OWNER'S MANUAL

MULTI-COLOR LED WATERFALL CASCADE

Model CLW090

READ AND FOLLOW ALL INSTRUCTIONS BEFORE USING THIS PRODUCT

WARNING

- Assembly and disassembly by adults only.
- This is not a toy. Do not allow children to play with this product.
- Never grab, pull, push, lean on or obstruct the waterfall at any time.
- Ensure all the clamp screws, adaptor and hose are securely attached.
- This product is intended to be used only for the purposes described in the manual.

FOLLOW THESE RULES AND ALL INSTRUCTIONS TO AVOID PROPERTY DAMAGE OR OTHER INJURY.

General

- No tools are required for the assembly.
- Fits all round and rectangular Metal Frame, Prism and Ultra Frame pools (not suitable for Easy Set, Oval and Panel pools).
- Built-in hydroelectric generator powers the LED light, no batteries or electrical connection required.
- Lights in 3 colors: green, blue and red. Preset 5 seconds between colors change. Best seen at night or under low light condition.
- Pump flow rate required: 3,785 – 12,112 L/h (1,000-3,200 g/h). System flow rate required: 3,700 - 9,274 L/h (970 - 2,450 g/h).
- Make sure the pump and the pool are setup, and the pool is filled with water **just below the water return inlet connection.**
- Remove the waterfall before placing a pool cover over the pool.
- Store the product indoors when not in use.
- For pool and filter pump problems refer to their respective owner's manual.

©2023 Intex Marketing Ltd. - Intex Development Co. Ltd. - Intex Recreation Corp. All rights reserved/Tous droits réservés/Todos los derechos reservados/Alle Rechte vorbehalten. Printed in China/Imprimé en Chine/Impreso en China/Gedruckt in China.
®™ Trademarks used in some countries of the world under license from®™ Marques utilisées dans certains pays sous licence de/Marcas registradas utilizadas en algunos países del mundo bajo licencia de/Warenzeichen verwendet in einigen Ländern der Welt in Lizenz von/Intex Marketing Ltd. to/a/an Intex Development Co. Ltd., Hong Kong & Intex Recreation Corp., P.O. Box 1440, Long Beach, CA 90801
• Distributed in the European Union by/Distribué dans l'Union Européenne par/Distribuido en la unión Europea por/Vertrieb in der Europäischen Union durch/Intex Trading B.V., Ettenseweg 46, 4706 PB Roosendaal - The Netherlands • Distributed in the UK by **Unitec Service (UK) Limited**, 21 Holborn Viaduct, London EC1A 2DY, UK.
www.intexcorp.com

INTEX®

SAVE THESE INSTRUCTIONS

PARTS LIST

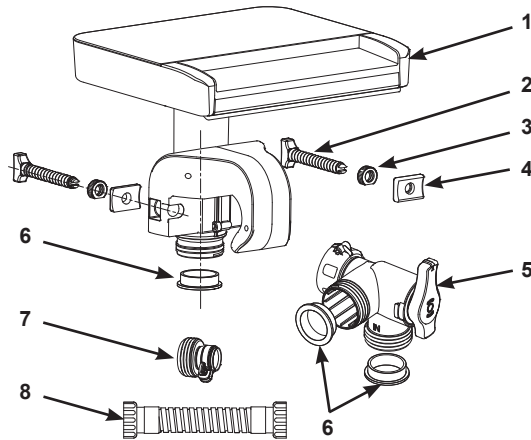

NOTE: Drawings for illustration purpose only. May not reflect actual product. Not to scale.

REF. NO.	DESCRIPTION	QTY.	SPARE PART NO.
1	Waterfall set	1	12556
2	Clamp screw	2	12560
3	Clamp nut	2	12561
4	Fixer	2	12565
5	Bypass valve	1	12569
6	L-shape O-ring	3	11228
7	Adaptor B	1	10722
8	Connecting hose	1	11535

Due to a policy of continuous product improvement, Intex reserves the right to change specifications and appearance, which may result in updates to the instruction manual without notice.

Setup

1. Locate the pool water return inlet connection or plunger valve.
2. To maximize the performance of the waterfall, place the waterfall to the left side and within reach of the water return inlet connection or plunger valve, as there is less twisting of the bypass connecting hose (8).
3. Place the waterfall clamp over the frame pool horizontal top beam. Make sure it is on the left side and within reach of the water return inlet connection or plunger valve. Securely tighten the clamp screws by hand. **See fig 1 - 3.**

SAVE THESE INSTRUCTIONS

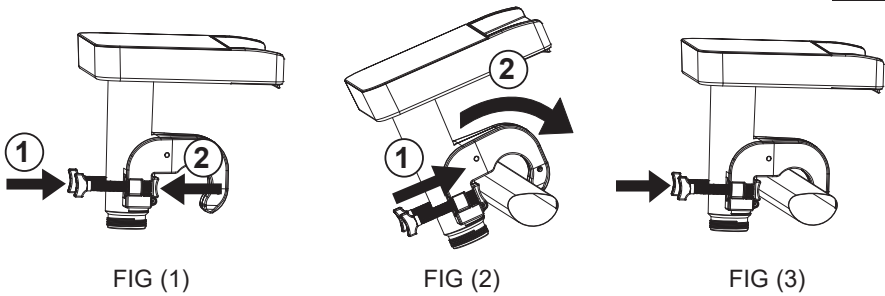

4. For pools with plunger valve and 38mm (1.5 in) hose:
 - a. Close the water outlet plunger valve.
 - b. Make sure the pump is off and disconnect the pump return hose from the pool inlet plunger valve.
 - c. Remove the pool inlet plunger valve from the inlet threaded connector. This plunger valve will not be needed, store in a safe place.
 - d. Attached the bypass valve (5) to the pool inlet threaded connector and tighten the collar nut by hand.
 - e. Reconnect the pump return hose to the bypass valve (5) lower port. See fig 4.

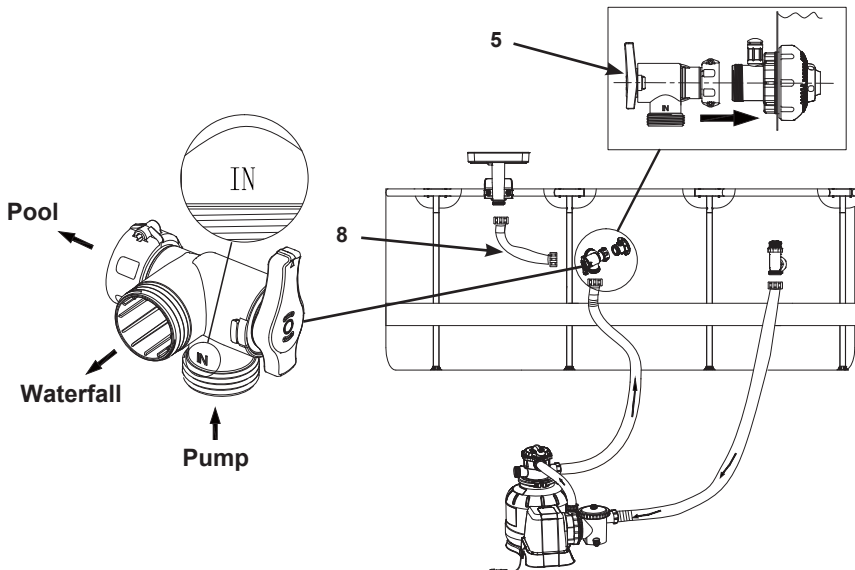

SAVE THESE INSTRUCTIONS

5. For pools with 32mm (1.25 in) hose connections:
 - a. From the inside of the pool, insert the strainer hole plug into the water outlet fitting.
 - b. Make sure the pump is off and disconnect the pump return hose from the pool inlet fitting.
 - c. Attach the adaptor B (7) to the pool inlet fitting and securely tighten the clamp by hand.
 - d. Attach the bypass valve (5) to the adaptor B (7) and tighten the collar nut by hand.
 - e. Reconnect the pump return hose to the bypass valve (5) lower port. **See fig 5.**
6. Attach the connecting hose (8) between the waterfall (1) and the bypass valve (5) left side port. **See fig 4 - 5.**

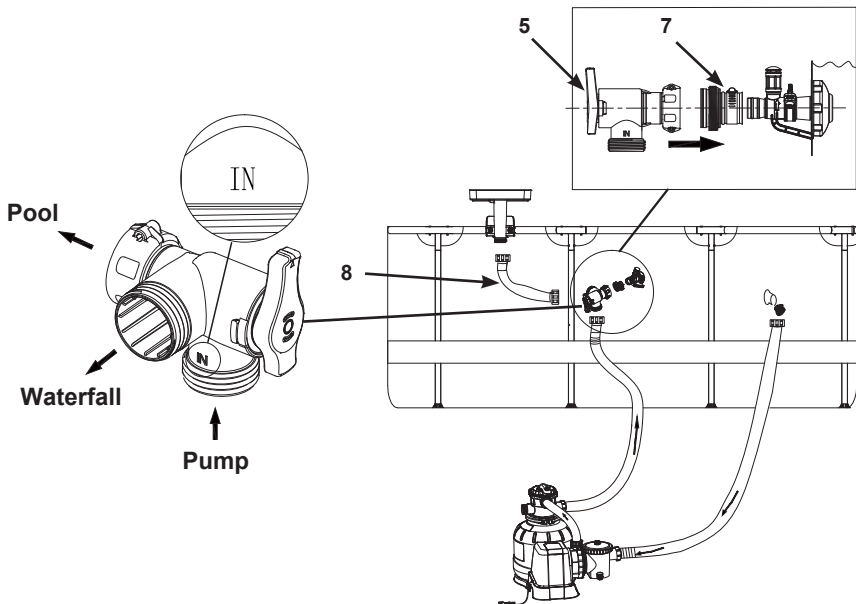

FIG (5)

7. Bypass valve (5) handle setting:
 - a. Pool position (handle pointing down): water flow from pump to pool. **See fig 6.**
 - b. Waterfall position (handle pointing up): water flow from pump to waterfall. **See fig 7.**
 - c. Never set the bypass valve handle between pool and waterfall position (handle pointing left or right side), as this will affect the performance of the waterfall and the pump. **See fig 8.**

SAVE THESE INSTRUCTIONS

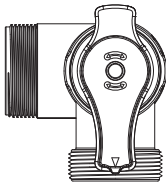

FIG (6)

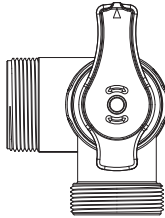

FIG (7)

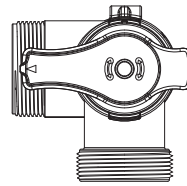

FIG (8)

8. Resume filling the pool with water to the recommended level.
9. Open the water outlet plunger valve or remove the strainer hole plug from the outlet fitting.
10. Turn on the pump and purge all the air out from the hoses and pump.

Maintenance and Long Term Storage

1. Regularly check all components for sign of damage, straining. Discard and replace damaged components immediately.
2. Use a sponge and clean water to wipe away any soil or stains.
3. Disassemble the product when the temperature drops below 5°C (41°F) by reversing the above setup instructions, drain the water out of the waterfall, and make sure all components are completely dry before storage.
4. Store the waterfall and accessories in a dry, temperature controlled, between 0° – 40°C (32° – 104°F), storage location.
5. The original packing can be used for storage.

TROUBLE	SOLUTION
Light is off / flashing	<ul style="list-style-type: none"> • Make sure the filter pump is operating, the pump water return hose is attached to the bypass valve lower port and the bypass valve is in the waterfall position (handle pointing up). See "Setup" section. • Make sure the connecting hose (8) is attached between the waterfall and the bypass valve left port. • Check if the pump system flow rate is within the specified range, if the system flow rate is less than 3,700 L/h (970 g/h), change pump with higher system flow rate. • Clean or replace the filter pump cartridge. If using a sand filter, ensure the sand media is clean by backwashing it. • Use a garden hose to wash the waterfall opening, check to see if any sand or deposits inside the waterfall set. • Contact Intex Service Center.
Poor water cascade performance	<ul style="list-style-type: none"> • Use a damp cloth to wipe away any dirt on the waterfall opening. • The performance depends on the filter pump flow rate. If you are not satisfied with the water cascade performance, a higher flow rate filter pump is recommended.

SAVE THESE INSTRUCTIONS

Limited Warranty

Your Waterfall has been manufactured using the highest quality materials and workmanship. All Intex products have been inspected and found free of defects prior to leaving the factory. This Limited Warranty applies to the Waterfall only.

This limited warranty is in addition to, and not a substitute for, your legal rights and remedies. To the extent that this warranty is inconsistent with any of your legal rights, they take priority. For example, consumer laws across the European Union provide statutory warranty rights in addition to the coverage you receive from this limited warranty: for information on EU-wide consumer laws, please visit the European Consumer Center website at http://ec.europa.eu/consumers/ecc/contact_en/htm.

The provisions of this Limited Warranty apply only to the original purchaser and are not transferable. This limited warranty is valid for the period noted below from the date of the initial retail purchase. Keep your original sales receipt with this document, as proof of purchase will be required and must accompany warranty claims or the Limited Warranty will be invalid.

Waterfall Set Warranty – 1 Year
Hoses & Fittings Warranty – 180 days

If you find a manufacturing defect in the Waterfall during the warranty periods noted above, please contact the appropriate Intex Service Center listed in the separate "Authorized Service Centers" sheet. If the item is returned as directed by the Intex Service Center, the Service Center will inspect the item and determine the validity of the claim. If the item is covered by the provisions of the warranty, the item will be repaired or replaced, with the same or comparable item (at Intex's choice) at no charge to you.

Other than this warranty, and other legal rights in your country, no further warranties are implied. To the extent possibly in your country, in no event shall Intex be liable to you or any third party for direct or consequential damages arising out of the use of your Waterfall, or Intex or its agents' and employees' actions (including the manufacture of the product). If your country does not allow the exclusion or limitation of incidental or consequential damages, this limitation or exclusion does not apply to you.

You should note that this limited warranty does not apply in the following circumstances:

- If the Waterfall is subject to negligence, abnormal use or application, accident, improper operation, improper voltage or current contrary to operating instructions, improper maintenance or storage;
- If the Waterfall is subject to damage by circumstances beyond Intex's control, including but not limited to, ordinary wear and tear and damage caused by exposure to fire flood, freezing, rain, or other external environmental forces;
- To parts and components not sold by Intex; and/or.
- To unauthorized alterations, repairs or disassembly to the Waterfall by anyone other than Intex Service Center personnel.

Injury or damage to any property or person is not covered by this warranty.

Read the owner's manual carefully and follow all instructions regarding proper operation and maintenance of your Waterfall. Always inspect your product prior to use. This limited warranty will be void if use instructions are not followed.

SAVE THESE INSTRUCTIONS